

THE TOUGHEST
PERFORMER
FOR YOUR FIELD



COMFORTABLE CABIN
DESIGNED TO
BOOST FARMING

N SERIES
N90 | N75

www.solistractors.com

5

AMONG TOP 5 TRACTOR
MANUFACTURERS
GLOBALLY

1

NO. 1 TRACTOR
EXPORTER FROM
INDIA



EMINENT PRESENCE
IN 150+ COUNTRIES



WORKFORCE OF
6000+ DEDICATED EMPLOYEES
WITH 500+ ENGINEERS IN R&D



JOINT VENTURE
WITH YANMAR (JAPAN)



INTERNATIONAL TRACTORS LIMITED

International Business Office: Teri School of Advanced Studies, Plot No.10, Institutional Area, Vasant Kunj, New Delhi-110070 (India)
Phone: +91 11 66 45 5200 | Work: Jalandhar Road, Hoshiarpur - 146022, Punjab (India) | Phone: +91-01882-522220/ 522221
Fax: +91- 01882-522222 | Email: info@solisworld.com | URL: www.solistractors.com

Follow us on:

- www.facebook.com/SolisTractors/
- www.twitter.com/SolisTractor
- www.linkedin.com/company/solis-tractors-international
- www.instagram.com/solis_tractors
- www.youtube.com/c/SolisTractors

BUILT FOR THE NARROW FIELD



These tractors are engineered to glide through orchard rows and vineyard lanes with unmatched agility. The Solis NT Series is crafted for orchard and vineyard farming, combining precision, efficiency, and comfort. Delivering maximum power in limited spaces, it helps farmers achieve more without compromise. With decades of expertise, Solis has become one of the fastest-growing tractor brands, trusted in 150+ countries. The NT Series continues this legacy with advanced engineering and farmer-focused design, redefining narrow farming.

ENGINEERED FOR EASE



NEW S-TECH ENGINE

- 4 CYLINDER TURBOCHARGED STAGE V ENGINE
- BEST-IN-CLASS TORQUE
- BEST-IN-CLASS ENGINE CAPACITY

POWERFUL TRANSMISSION

- 12F+12R SYNCHRO SHUTTLE TRANSMISSION WITH AUTO CREEPER
- INDEPENDENT PTO

S COMMAND CENTER

- WIDER WORKSPACE
- TILTABLE / TELESCOPIC POWER STEERING
- INTEGRATED LOADER JOYSTICK
- S-CONNECT SYSTEM (TELEMATICS)
- BEST-IN-CLASS CAB VOLUME

CAT-IV CAB

- ALL-WEATHER COMFORT
- OPERATOR-FRIENDLY
- ENHANCED VISIBILITY
- PREMIUM SEATING
- SAFETY SWITCHES

S-BOOST HYDRAULIC

- 2500 KG LIFT CAPACITY
- 2DA STD / 3DA (OPTIONAL)
- 45 LPM FLOW RATE
- 88 LIT. TOTAL HYDRAULIC FLOW
- FIXED & QUICK ATTACH TPL

SPECIAL FEATURES

- UNMATCHED TORQUE IN THE OPTIMAL OPERATING BAND
- UNIQUE FLAT FLOOR WITH TOP-CLASS OPERATOR COMFORT
- CAT-4 PRESSURISED CABIN FOR PROTECTION AGAINST HARMFUL CHEMICALS
- IDEAL WHEELBASE OFFERING TOP-NOTCH STABILITY
- OVERALL WIDTH OF 1400 MM
- BIAS/RADIAL TYRE OPTIONS
- LOW TURNING RADIUS (3370 MM)

NEW S-TECH ENGINE

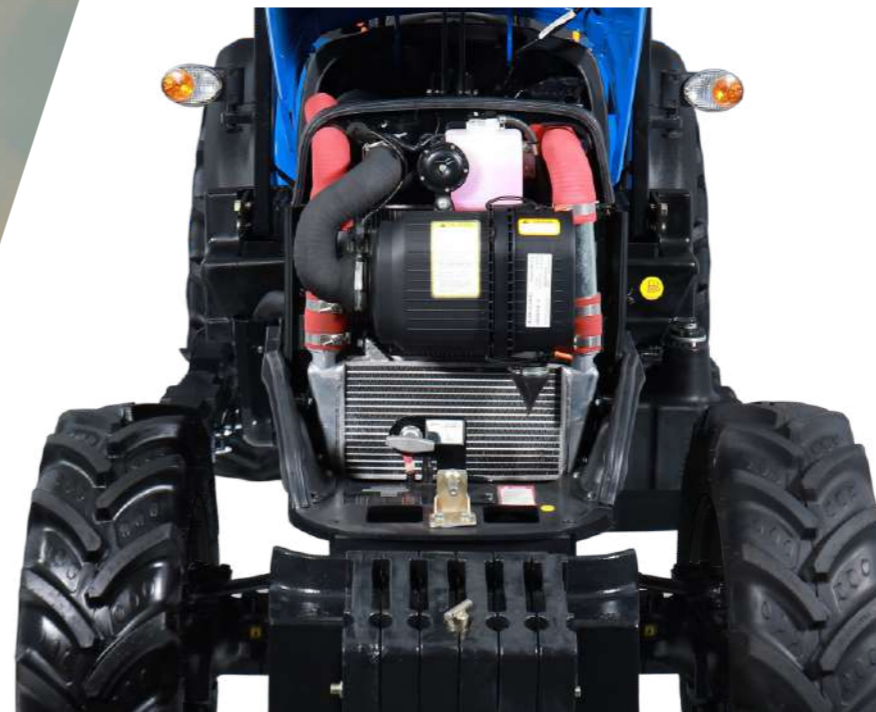

UNMATCHED TORQUE FOR OPTIMAL OPERATING RANGE

The tractor is driven by a cutting-edge 4-cylinder Stage V engine with turbocharging, delivering impressive torque and fuel-efficient performance. Whether you're tackling challenging tasks or running long hours, it ensures strong, reliable output with lower fuel consumption. These advanced features enable greater productivity and unmatched efficiency across all types of applications.

FLAT TORQUE CURVE

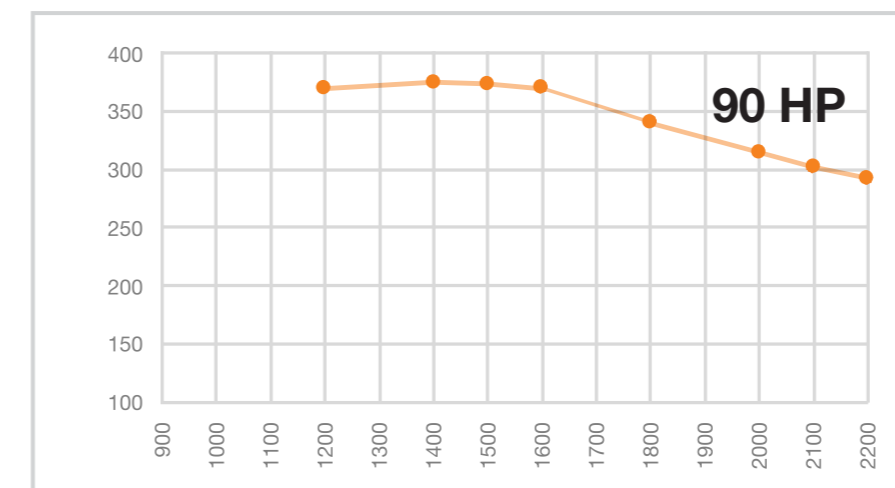

SPECIAL FEATURES:

- 4 Cylinder Turbocharged Engine
- Compliant with Stage-V Emission Norms
- High-end Torque of 375 Nm (90 Hp) & 340 Nm (75 Hp) with Better Torque in Operating Range for Applications
- Block Heater (opt.)
- Best-in-Class Torque
- Best-in-Class Engine Capacity for Unmatched Power
- Low-rated Engine RPM

POWERFUL TRANSMISSION



SMOOTH & SMART TRANSMISSION

Equipped with a sturdy synchromesh gearbox offering 12 forward and 12 reverse speeds, along with F/R shuttle and 4WD capabilities, this transmission system delivers seamless gear shifts and smooth handling, perfect for varied terrains and demanding operations.

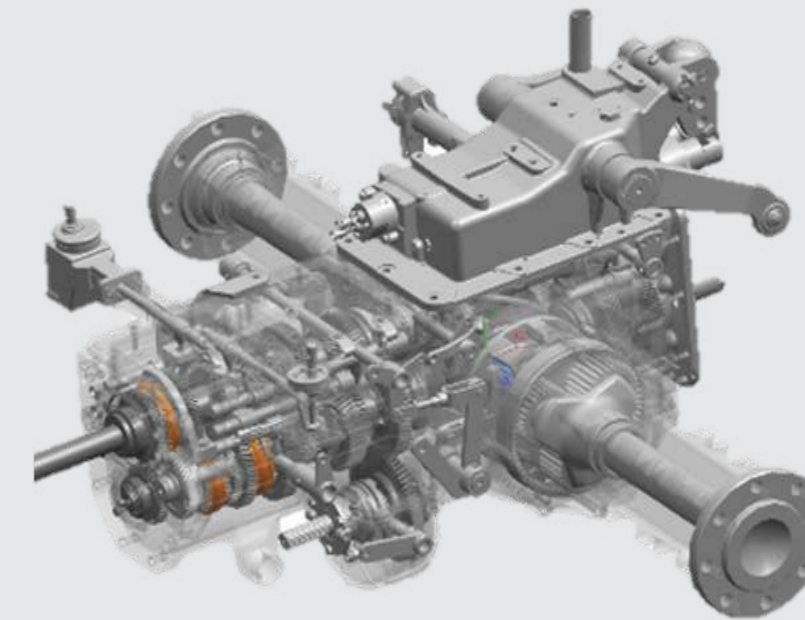

SPECIAL FEATURES: TRANSMISSION

- Synchromesh Transmission
- Forward/Reverse Synchro Shuttle
- 12F+12R Speeds
- Agri Bias/Radial Tyre
- Standard Creeper Speed
- Hydraulic Trailer Brakes

S-BOOST HYDRAULICS



ADVANCED S-BOOST HYDRAULICS

The advanced S-Boost hydraulic system offers a robust 2500 kg lifting capacity and intuitive PC/DC controls. With adaptable hitching options like CBM, automatic, CUNA, and intuitive PC/DC controls, it ensures effortless attachment handling and supports high-performance applications.

SPECIAL FEATURES:

S-BOOST HYDRAULICS

- 2500 KG lift capacity
- CAT-II Three-point linkage

REAR HITCHES

- E-marked swinging bar (std.)
- CBM Ladder hitch (Opt.)
- Cuna (X type & Y type) Hitch (Opt.)

AUXILIARY OUTPUTS

- Telescopic & Self Locking TPL (Opt.)
- Pin Type Stay bar for limited movement of stay bars
- 2DA (Std.)
- 3DA (Opt.)

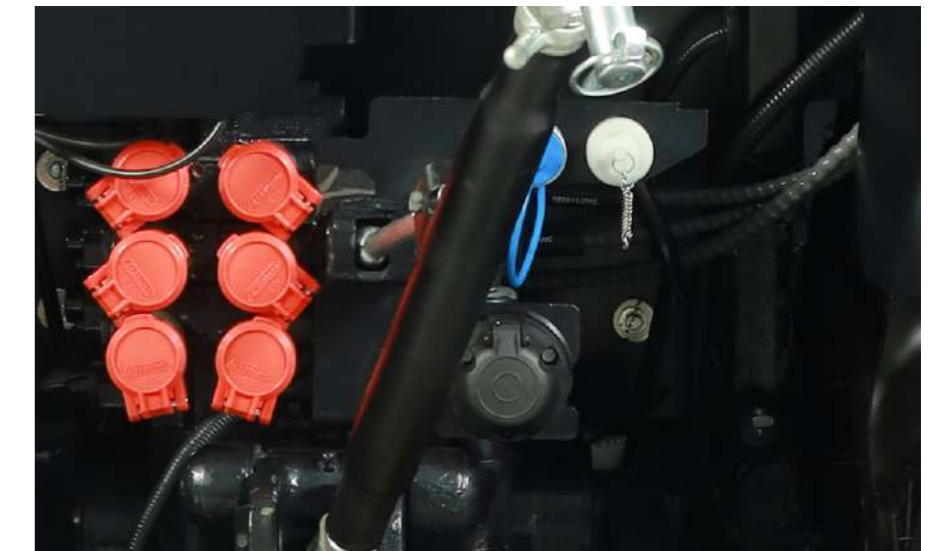



TOUGH AND STYLISH



DEFINE YOUR STYLE WITH UNRIVALLED DURABILITY

Solis tractors are renowned for their sturdy build and advanced engineering, ensuring consistent performance even under the harshest conditions, thereby establishing their reliability. The sleek designs create a unique aesthetic appeal, complemented by a flat floor and best-in-class cab volume that enhance operator comfort. With fatigue-free operation at its core, every drive becomes more productive and effortless.

SPECIAL FEATURES:

- Flat Floor
- Best-in-Class Cab Volume
- Fatigue Free Operation
- 100% Metal Hood
- Twin Projector Lamps
- Single Piece Hood with Wider Opening
- Aerodynamic Front Hood
- Front Fenders



REDEFINING COMFORT WITH CAT-IV CAB

CAT-4 PRESSURISED CABIN FOR PROTECTION AGAINST HARMFUL CHEMICALS

The Cat IV CAB is your ultimate shield in the field, a fortress of innovation crafted to keep farmers safe, comfortable, and empowered. With advanced technology, the Cat IV CAB seals out dust, heat, and harmful chemicals, ensuring a healthier workspace every day. Inside, first-class comfort takes charge with ergonomic seating, climate control, and noise reduction, transforming long hours into effortless productivity. More than just a cabin, the Cat IV CAB is a promise that the farmer who feeds the world deserves nothing less than protection, luxury, and the future of farming at their fingertips.



SPECIAL FEATURES:

SAFETY NORMS

- Neutral Safety Switch
- PTO Safety Switch
- Clutch Safety Switch
- Battery Cut-Off Switch

STANDARD FEATURES

- Tiltable & Telescopic Steering
- CAT IV CAB
- 2DA
- Music System
- CAB Lights
- Swinging Draw Bar



CAT-4 CABIN

NARROW SPECIALIST



TAME VINEYARD CHALLENGES WITH EASE

Wheelbase Designed for Superior Stability

The Solis tractor stands out for being compact yet powerful, making it ideal for vineyards, orchards, and various forms of compact farming. It delivers exceptional results in confined spaces, and its versatility makes it the perfect choice for farmers seeking optimal productivity in limited areas.



| DIMENSIONS | | N75 | N50 |
|------------|-----------------------------|-----------|-----|
| A | Overall Length (mm) | 4030-4300 | |
| B | Overall Width (mm) | 1400-1515 | |
| C | Overall Height (mm) | 2300-2330 | |
| D | Wheel Base (mm) | 2310 | |
| E | Min. Ground Clearance | 290-320 | |
| F | Front Wheel Track Agri (mm) | 1150-1210 | |
| G | Rear Wheel Track Agri (mm) | 1000-1110 | |

SPECIAL FEATURES:



- A. : Speed Range Lever
- B. : PTO Gear Lever
- C. : IPTO Lever
- D. : 540/540E PTO Lever

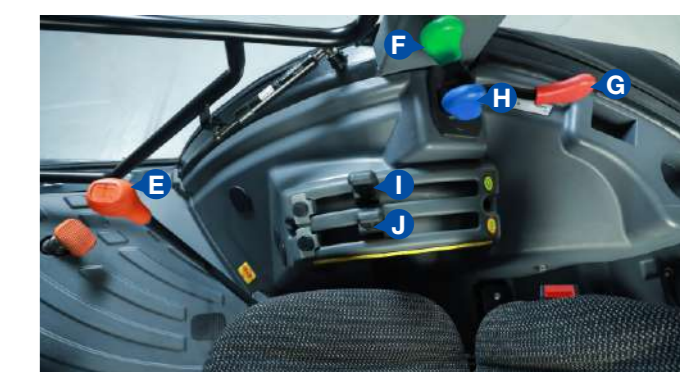

- E. : Gear Lever
- F. G. H. : DCV Control Levers
- I. : Position Control Lever
- J. : Draft Control Lever

S-COMMAND CENTER



EXPERIENCE THE DIFFERENCE OF A UNIQUE FLAT FLOOR

Solis tractor offers the S-Command Center, which revolutionises farming operations with its intuitive interface and advanced features. Solis tractor prioritises operator well-being. Its spacious workspace provides ample room for efficient operation, while the integrated joystick simplifies control, allowing operators to focus on maximising productivity with ease and confidence.



SPECIAL FEATURES:

WIDE & OPEN PLATFORM

- HVAC System for Better Work Environment
- Best-in-class Workspace
- Wider Foot Step
- Bigger Entry Area
- Easy Approach to Levers
- Easy Mounting on Tractor
- Flat Platform for Operator

ADJUSTABLE SEAT

- (Optional Seat)
- Bucket Design
 - Soft Cushioning
 - Back Support
 - Front Back Adjustable
 - Easy Approach to all Levers
 - Seat Belt
 - Utility Box at the Back



ENHANCED SAFETY SHIELD



SHIELD YOURSELF WITH CONFIDENCE ON EVERY RIDE

Ensuring operator safety, the Solis tractor safety shield excels in this aspect. Designed with precision and durability in mind, it offers robust protection against potential hazards such as debris and moving parts, enabling operators to work with confidence and peace of mind.

SPECIAL FEATURES:

- A. Tilttable Steering Lever
- B. 12V Socket
- C. Signature Light Switch
- D. Hazard Switch
- E. External PTO Control Switch

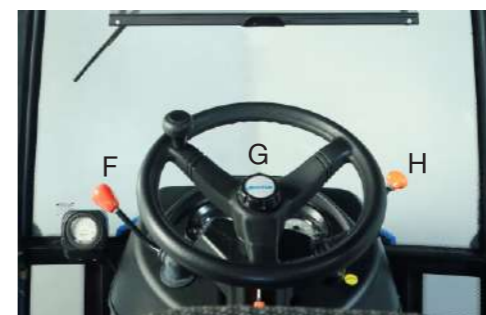
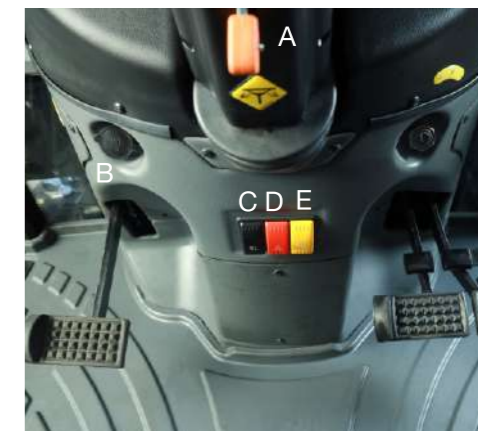

- F. F/R Shuttle Lever
- G. Telescopic Steering Knob
- H. Hand Accelerator

ADVANCED TECHNOLOGY FEATURES



UNDER HOOD LIGHT

FRONT GUIDE LIGHT



EXPLORE NEXT-LEVEL TECHNOLOGY

Solis tractors are equipped with advanced technology features that offer farmers exceptional control and efficiency in their operations. Their high versatility allows them to adapt to a wide range of tasks, optimising productivity and yield.



SPECIAL FEATURES:

LIGHTING INSTALLATIONS

- Quad Projector Lamps
 - Clear Outline Beam
 - High-Intensity Illumination
 - 7m Range
 - Clear Visibility
 - 24-Hour Working
- Beacon Light
- Front Indicator Lamps
- Front Guide Light (Opt.)
- Under-hood Light for Easy Serviceability (Opt.)
- LED Work Lamps (Cabin Model) (Opt.)
- LED Work Lamp (ROPS Model) (Opt.)

INTERACTIVE CLUSTER

- Digital Display
- RPM Meter
- Oil Temperature Indicator
- Fuel Indicator Gauge
- Error Codes on Display
- Speed in km/h or mph
- PTO RPM Indication
- PTO RPM Set Indication
- Improved Sensors with Water Protection
- Water-Sealed Connectors
- Battery Cut-off Switch (Operated Inside Cabin)



Solis NT Series is better positioned than its competition, delivering nearly 40–50% more advantage with its smart design and advanced engineering. A perfect blend of the right features and cutting-edge technology, it empowers farmers with smart farming solutions tailored for orchards and vineyards.

SPECIFICATIONS

| FEATURES | <i>N90</i> | <i>N75</i> |
|--|--|-------------------------------|
| ENGINE | | |
| No. of Cylinders / Capacity (cc) / Emissions Level | 4/ 4087/ CRDi Stage V | 4/ 4088/ Stage V |
| After Treatment System | DOC + DPF + SCR (Ad-Blu) | DOC + DPF |
| Rated Engine Power (kw/Hp) | 67.3/90 | 54.83/ 73.47 |
| Rated Engine Speed | 2200 | 2000 |
| Max. Torque (Nm) | 375Nm @ 1400 Rpm | 340Nm @ 1400 Rpm |
| Aspiration | Turbo charged | Turbocharged with Intercooler |
| Air Cleaner | Dual Stage Dry Type | |
| Block Heater | ○ | |
| Downdraft Exhaust Pipe | ● | |
| Fuel Tank Capacity (Ltr.) (Cab) | 80 | |
| DEF Tank Capacity (Ltr.) | 10 | - |
| TRANSMISSION | | |
| 12x12 Synchro Shuttle Transmission | ● | |
| Minimum/Maximum Speed | 0.5 kmph / 30 Kmph | 0.45 kmph/ 30 Kmph |
| 24x24 Synchro Shuttle Transmission | ○ | |
| Minimum/Maximum Speed | 0.5 kmph / 40 Kmph | - |
| Clutch | Double | |
| FRONT AXLE | | |
| 4WD Front Axle | ● | |
| Differential Lock | Mechanical | |
| 4WD Actuation | Mechanical | |
| Brake Actuation | Mechanical | |
| PTO | | |
| PTO Type | Independent | Mechanical |
| 540/540E | ● | |
| HYDRAULIC | | |
| Hydraulic Pump Flow (LPM) | 56 | |
| Open Centre Mechanical Draft Control | ● | |
| Top Link Draft Sensing | ● | |
| Lift Capacity (kg) | 2500 | |
| Linkage Category | Cat-II | |
| Self Locking TPL Linkages | ○ | |
| Max. No. of Rear Remotes | 2DA/3DA (Float with detent, self centered, Kick out) | |
| REAR HITCHES | | |
| E-Marked Swinging Bar | ● | |
| CBM Ladder Hitch | ○ | |
| Cuna (X Type & Y Type) Hitch | ○ | |
| Clevis Type Hitch | ○ | |

SPECIFICATIONS

| FEATURES | <i>N90</i> | <i>N75</i> | |
|--|-------------------------------------|------------------------|------------------------|
| TRAILER BRAKES | | | |
| Without Trailer Brakes | ● | | |
| Hydraulic Trailer Brakes (DHTB) | ○ | | |
| ELECTRICALS (ROPS/CAB) | | | |
| Battery | 110AH 800CCA | - | |
| Alternator | 90A | - | |
| Button Operated Battery Cut off Switch, 3 Pin Socket, Seven Pin Trailer Socket | ● | ● | |
| OPERATOR ENVIRONMENT | | | |
| Suspended Platform (with ROPS) | ● | | |
| Normal Driver Seat w/o Armrest | ● | | |
| Tilttable & Telescopic Steering | ● | | |
| Front Mud Guards | ○ | | |
| Ballast Weights (31*6) Kg | ○ | | |
| Ballast Rear Weights (30*2) Kg | ○ | | |
| Cabin Air Conditioning (With HVAC) | ○ | | |
| CAT IV Cabin | ○ | | |
| DIMENSIONS (ROPS/CAB) | | | |
| Weight (kg) | 3295-3545 | 3295 | |
| Wheelbase (mm) | 2310 | 2300 | |
| Overall Length (mm) | 4030-4300 | 4305 | |
| Overall Width (mm) | 1400-1515 | 1495 | |
| Overall Height (mm)* | 2300-2330 | 2365 | |
| Front Track Width (mm) | 1150-1210 | 1200 | |
| Rear Track Width (mm) | 1000-1110 | 1070 | |
| Ground Clearance (mm) | 290-320 | 265 | |
| Additional Weight (kg) | | | |
| Front | 79 Kg Base Weight + 6*31 Kg Weights | - | |
| Rear | 1*30 Kg on Each Side Wheel | - | |
| OPTIONAL TYRES (ROPS/CAB) | | | |
| | Standard | 8X18 & 14.9-24 (Agri) | 8.00-18 & 14.9-24 |
| | Option 1 | 8X18 & 13.6X24 (Agri) | 8x18 * 13.6X24 |
| | Option 2 | 280/70 R18 & 380/85R24 | 280/70R18 & 380/85R24 |
| | Option 3 | 210/95R18 & 360/70R28 | 210/95R18 & 360/70R28 |
| | Option 4 | 280/70R18 & 420/70R24 | 280/70R18 & 420/70R24 |
| | Option 5 | 260/70R16 & 360/70R24 | 260/70R16 & 360/70R24 |
| | Option 6 | 280/70R18 & 360/70 R28 | 280/70R18 & 360/70 R28 |

● Standard ○ Optional

*Data and specifications are subject to change without any advance notice due to continuous product improvement and development. All Dimensions are with standard tyres.



**REDEFINING
ORCHARD &
VINEYARD
FARMING**