



Solis

— THE TOUGHEST — **PERFORMER** « FOR YOUR FIELD »

EFFICIENT • VERSATILE • COMPETENT



S16

S20

S22

H26

S26

S26
SHUTTLEXL



THE NEXT GENERATION TECHNOLOGY

XTRA

EXTRA EFFICIENT TRACTORS FOR YOUR WORK

HIGH LIFTING CAPACITY

HEAVY DUTY AXLE

NEXT GENERATION TRANSMISSION





ADVANCED TECHNOLOGY EDGE

REINFORCED SAFETY FEATURES

FRICTIONLESS AERODYNAMICS BONNET

S5 ENGINE

- 16
- 20
- 22
- 26
- 26 SHUTTLE XL
- H26

EXTRA POWERFUL **S5 ENGINE**

Pace ahead with precision in power packed engine capacity. With user-friendly & eco-friendly features, S5 engine redefines power and performance on the field.

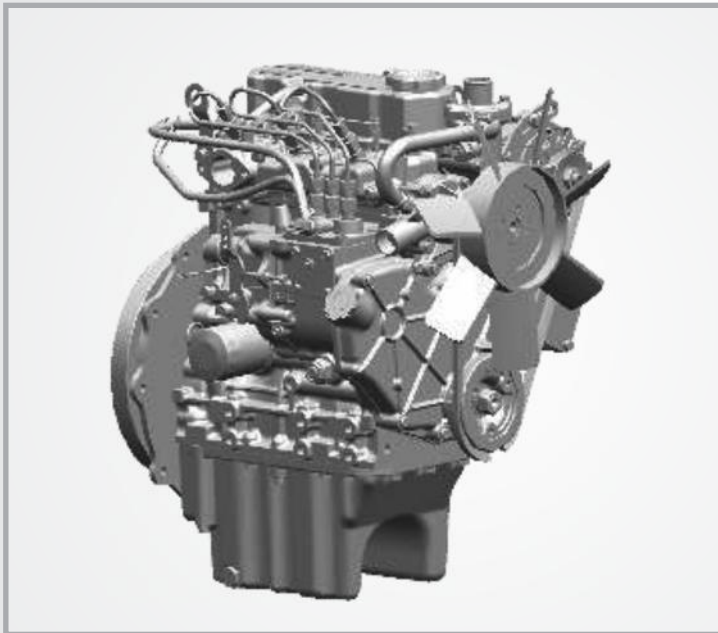

**EXTRA EFFICIENT
STAGE V ENGINE**



**LOW
MAINTENANCE**



**HIGH
BACK UP
TORQUE**



**BETTER
COOLING**



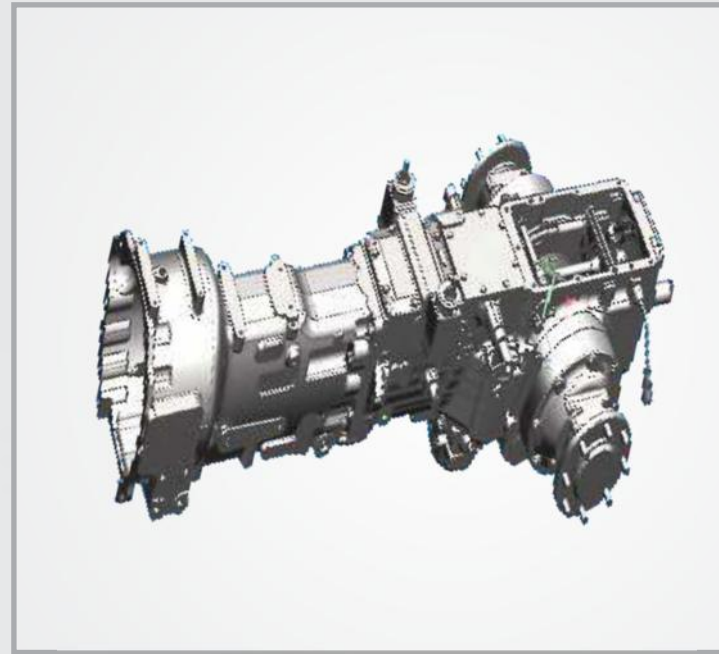

NEXT GEN **TRANSMISSION**

The transmission potential of the tractor is at par with the global standards. The in-built speed precision field features allow high productivity on the field.



MECHANICAL
TRANSMISSION



HST
TRANSMISSION

EXTRA POWERFUL LIFTING CAPACITY

Amplifying every task with its high lifting capacity, this tractor enables ease of operations and performs like a champion.



**EFFICIENT
HYDRAULIC
PUMP**



**STANDARD DOUBLE
ACTUATING
AUXILIARY VALVE**



**SMOOTH
LIFTING**





GLOBAL **STYLING**

The sleek and stylish bonnet is designed to provide better ground control and increase the user comfort.



**SLEEK
& STYLISH
BONNET**



**AERODYNAMIC
BONNET**



**STYLISH
PROJECTOR
LAMPS**

EXTRA POWERFUL SAFETY FEATURES

Achieve a seamless experience with our reinforced safety features and work hassle-free, even in the most difficult terrains & conditions.



OPC
(OPERATOR
PRESENCE
CONTROL)



TIMEOUT
ALARM



HAZARD
WARNING



INTEGRATED
CONTROL



SAFETY
SHUT DOWN
WITH PTO
ENGAGEMENT





S COMFORT PACKAGE

Designed to enhance the user experience, the extra comfort features add to ease of operations and make it more efficient and productive.



ERGONOMICALLY
DESIGNED



SPACIOUS
OPERATOR
AREA



COMFORTABLE
SEAT WITH
FOLDABLE
ARMREST*



REDEFINING PRODUCTIVITY **WITH THE GARDEN EXPERT**

A tractor that enables all your garden and farming needs, this power performer is empowered with a power steering to help reduce operational stress for the user. The powerful 4 wheel drive and effective traction capacity of SOLIS S16 facilitates smooth operations and the sliding mesh transmission enables speed precision.



**3 CYLINDER
STAGE "V" ENGINE**











**SLEEK
& STYLISH
BONNET**













**MECHANICAL
TRANSMISSION**



SPECIFICATIONS

FEATURES	16
ENGINE 	
Engine Type	ITL 3 Cylinder
HP Category	16
No. of Cylinders	3
Aspiration	Naturally
Cubic Capacity (cc)	979
Rated RPM (+/-25mm)	2700
Air Cleaner	Dry with clogging sensor
Cold Start	Standard
Max Torque (Nm)	48
Exhaust	Silencer in the engine compartment, downward discharge
TRANSMISSION 	
Drive	4 WD
Clutch	Single Clutch
Gearbox	6 Forward + 2 Reverse
Front Axle	4WD
Transmission	Sliding Mesh
SPEED (FORWARD) 	
Maximum Speed (Km/Hr)	15.1@2950
Minimum Speed (Km/Hr)	1.36@rated
BRAKES 	
Brakes	Dry drum brakes
Type of Actuation	Mechanical
Parking Brake	Independent
DIFFERENTIAL LOCK 	
Differential Lock	Yes, Foot Operated
PTO 	
PTO (rpm)	540, 1000
PTO (actuation)	Mechanical
STEERING 	
Steering	Mechanical
ELECTRICAL 	
Battery	12V, 60 Ah
Alternator	12V, 42 A
Seven Pin Trailer Socket	Standard
HYDRAULICS 	
3 Point Linkage	Cat 1-N
Stay Bars	Anchor Chain
Additional hydraulic circuit	1 DA

FEATURES	16		
Hydraulic Lifting Capacity	500 Kg		
Lift Rods	Standard		
Litre per Minute(LPM)	12		
SAFETY SWITCH 			
PTO Safety	Standard		
Neutral Safety Switch	Standard		
Clutch Safety Switch	Standard		
CAPACITY (LTRS)(+/-5%) 			
Fuel Tank (Lit)	26		
TURNING RADIUS 			
Without brakes (m) as per standard tyres	3.2 (RHS), 3.3 (LHS)		
TYRE 			
Front	5.00-12		
Rear	8.00-18		
DIMENSION & WEIGHT(+/-5%) 			
Weight (Kg)	970		
Wheel Base (mm)	1420		
Total Length (mm)	2735		
Total Width (mm)	945 (max) - 940 (min)		
Height (mm) Up to ROPS	1945		
Min Ground Clearance (mm)	200		
Front Track (mm)	805		
Rear Track (mm)	715		
OTHERS 			
Fuel Indicator Gauge	Standard		
Front Tow Hook	Standard		
Front & Rear Weights with std. Ballast	Front weights 30 Kg - 2 x 15 Kg		
Trailer Hitch	Drawbar / Optional Towbar		
ROPS	Yes		
OPTIONAL FEATURES 			
TYRES			
			
Radial Agri: Front Rear	Turf: Front Rear	Ind: Front Rear	Galaxy Pro
Front 6.5/80-12 Rear 280/70 R18	23x8.50-12 33x15.5-16.5	23x8.50-12 33x15.5-16.5	Front 220/55R12 Rear 280/70R16
Front loader	YES optional		

*Data and specifications are subject to change without any advance notice due to continuous product improvement and development.

VERSATILE PERFORMER

Our masterpieces towards innovation, Solis S20 & S26, are the heaviest tractors in their class. These strong and powerful heavy weight champions are made of complete metal increasing their productivity and efficiency on the field.



**HEAVYWEIGHT
TRACTOR**



**RADIAL AGRI, WIDER AGRI, INDUSTRIAL,
TURF TYRE OPTIONS**











**QUICK ATTACH LOADER & BUCKET
WITH 3rd ELECTRIC FUNCTION OPTION**













SOLIS 20

26

SPECIFICATIONS

FEATURES	≤20	≤26
ENGINE 		
Engine Type	3 Cylinder (Water Cooled) Engine	3 Cylinder Diesel Engine
HP Category	20	26
No. of Cylinders	3	
Aspiration	Naturally	
Cubic Capacity (cc)	953	1319
Rated RPM	2700	2500
Air Cleaner	Dry with clogging sensor	
Cold Start	Standard	
Max. Torque (Nm)	52	76.3
Exhaust	Silencer in the engine compartment, downward discharge	
TRANSMISSION 		
Drive	4WD	
Clutch	Single Clutch	
Gearbox	6 Forward + 2 Reverse	
Front Axle	4WD	
Transmission	Sliding Mesh	
SPEED (FORWARD) 		
Maximum Speed (Km/Hr)	15.1@2900	16.2@2815 fly up
Minimum Speed (Km/Hr)	1.36@rated	1.64@2500 rated
BRAKES 		
Brakes	Dry Drum Brake	Oil Bath Brake
Type of Actuation	Mechanical	
Parking Brake	Independent	
DIFFERENTIAL LOCK 		
Differential lock	Yes, Foot Operated	
PTO 		
PTO (rpm)	540, 1000	
PTO (Actuation)	Mechanical	
STEERING 		
Steering	Mechanical	Power Steering
ELECTRICAL 		
Battery	12 V, 60 Ah	12 V, 65 Ah
Type of Actuation	12V, 42 A	12V, 42 A
Parking Brake	Standard	

**Data and specifications are subject to change without any advance notice due to continuous product improvement and development.

FEATURES	≤20	≤26	
HYDRAULICS 			
3 Point Linkage	Cat 1 - N		
Stay Bars	Anchor Chain		
Auxiliary Hydraulic Circuit	1DA		
Lift Rods	Standard		
Lifting Capacity (Kg)	600		
Litre Per Minute (LPM)	13.3	13.5	
SAFETY SWITCH 			
PTO Safety	Standard		
Neutral Safety Switch	Standard		
Clutch Safety Switch	Standard		
CAPACITY (LITRE) (+/-5%) 			
Fuel Tank (Ltr.)	26	28	
TURNING RADIUS 			
Without Brakes (m)	3.2 (RHS), 3.3 (LHS)	3.18 (RHS), 3.10 (LHS)	
TYRE (STANDARD) 			
Front	5.00-12	6.00-12	
Rear	8.00-18	8.30-20	
DIMENSION & WEIGHT (+/-5%) 			
Weight (kg)	970	1070, 1265 with Cabin	
Wheel Base (mm)	1420	1560	
Total Length (mm)	2735	2760	
Total Width (mm)	945(max)-940(min)	1075 (max) - 1055 (min)	
Height (mm) Up to ROPS	1945	1955	
Min. Ground Clearance (mm)	200	240	
Front Track (mm)	805	885	
Rear Track (mm)	715	835	
OTHERS 			
Fuel Indicator Gauge	Standard		
Front Tow Hook	Standard		
Front & Rear Weights with Std. Ballast	Front weights 30 Kg - 2 x 15 Kg	Front weights - 2 x 15 Kg	
Trailer Hitch	Drawbar / Optional Towbar		
ROPS	Yes		
Cabin Option	Yes		
TYRES			
			
Radial Agri: Front Rear	Turf: Front Rear	Ind: Front Rear	Galaxy Pro
6.5/80-12 280/70 R18	23x8.50-12 33x15.5-16.5	23x8.50-12 33x15.5-16.5	220/55R12 280/70R16
Front loader	YES optional		

ELEVATING POTENTIAL

A tractor that enables all your garden and farming needs, this power performer is empowered with a power steering to help reduce operational stress for the user. The powerful 4 wheel drive and effective traction capacity of SOLIS S22 capacitates smooth operations and the sliding mesh transmission enables speed precision.



3 CYLINDER
STAGE "V" ENGINE



SLEEK
& STYLISH
BONNET























MECHANICAL
TRANSMISSION



SOLIS S22









SPECIFICATIONS











FEATURES	S22
ENGINE 	
Engine Type	ITL Make - GTV BB
HP Category	22
No. of Cylinders	3
Aspiration	Naturally
Cubic Capacity (cc)	1130 cc (1.13 ltr)
Rated RPM (+/-25mm)	2700
Air Cleaner	Dry with clogging sensor
Cold Start	Standard
Max Torque (Nm)	55
Exhaust	Silencer in the engine compartment, downward discharge
TRANSMISSION 	
Drive	4 WD
Clutch	Single Clutch
Gearbox	6 Forward + 2 Reverse
Front Axle	4WD
Transmission	Sliding Mesh
SPEED (FORWARD) 	
Maximum Speed (Km/Hr)	17.02@2950
Minimum Speed (Km/Hr)	2.13@rated
BRAKES 	
Brakes	Oil immersed brakes
Type of Actuation	Mechanical
Parking Brake	Independent
DIFFERENTIAL LOCK 	
Differential Lock	Yes, Foot Operated
PTO 	
PTO (rpm)	540, 1000
PTO (actuation)	Mechanical
STEERING 	
Steering	Power Steering
ELECTRICAL 	
Battery	12V, 65 Ah
Alternator	12V, 42 A
Seven Pin Trailer Socket	Standard
HYDRAULICS 	
3 Point Linkage	Cat 1-N
Stay Bars	Anchor Chain
Additional hydraulic circuit	1 DA

FEATURES	S22		
Hydraulic Lifting Capacity	600 Kg		
Lift Rods	Standard		
Litre per Minute(LPM)	13.7		
SAFETY SWITCH 			
PTO Safety	Standard		
Neutral Safety Switch	Standard		
Clutch Safety Switch	Standard		
CAPACITY (LTRS)(+/-5%) 			
Fuel Tank (Lit)	26		
TURNING RADIUS 			
Without brakes (m) as per standard tyres	3.28 (RHS), 3.15 (LHS)		
TYRE 			
Front	6.00-12		
Rear	8.30-20		
DIMENSION & WEIGHT(+/-5%) 			
Weight (Kg)	1070		
Wheel Base (mm)	1560		
Total Length (mm)	2750		
Total Width (mm)	1075 (max) - 1050 (min)		
Height (mm) Up to ROPS	1940		
Min Ground Clearance (mm)	230		
Front Track (mm)	875		
Rear Track (mm)	830		
OTHERS 			
Fuel Indicator Gauge	Standard		
Front Tow Hook	Standard		
Front & Rear Weights with std. Ballast	Front weights 30 Kg - 2 x 15 Kg		
Trailer Hitch	Drawbar / Optional Towbar		
ROPS	Yes		
OPTIONAL FEATURES 			
TYRES			
			
Radial Agri: Front Rear Front 6.5/80-12 Rear 280/70 R18	Turf: Front Rear 23x8.50-12 33x15.5-16.5	Ind: Front Rear 23x8.50-12 33x15.5-16.5	Galaxy Pro Front 220/55R12 Rear 280/70R16
Front loader	YES optional		

*Data and specifications are subject to change without any advance notice due to continuous product improvement and development.

SPECIFICATIONS

FEATURES		H26
ENGINE 		
Engine Type	3-Cylinder Diesel Engine	
HP Category	26	
No. of Cylinders	3	
Aspiration	Naturally	
Cubic Capacity (cc)	1319	
Rated RPM (+/-25mm)	2500	
Air Cleaner	Dry with clogging sensor	
Cold Start	Standard	
Max Torque (Nm)	76.3	
Exhaust	Silencer in the engine compartment, downward discharge	
TRANSMISSION 		
Drive	4 WD	
Clutch	Wet type clutch for PTO	
Gearbox	Hydrostatic	
Front Axle	4WD	
Transmission	HST (2-Stufen Hydrostat)	
SPEED (FORWARD) 		
Maximum Speed (Km/Hr)	21.03@2660	
Minimum Speed (Km/Hr)	3.18 at low idle 900 erpm, 8.83@rated erpm	
BRAKES 		
Brakes	Oil Immersed	
Type of Actuation	Hydrostatic	
Parking Brake	Independent	
DIFFERENTIAL LOCK 		
Differential Lock	Yes, Foot Operated	
PTO 		
PTO (rpm)	Mid PTO- 2100 RPM, Rear 540	
PTO (actuation)	Electro hydraulic operated/ mechanical selector lever	
STEERING 		
Steering	Power steering	
ELECTRICAL 		
Battery	12V, 65 Ah	
Alternator	12V, 42 A	
Seven Pin Trailer Socket	Standard	
HYDRAULICS 		
3 Point Linkage	Cat 1-N	
Stay Bars	Anchor Chain	
Additional hydraulic circuit	1 DA	

FEATURES		H26	
Hydraulic Lifting Capacity	600 Kg		
Lift Rods	Standard		
Litre per Minute(LPM)	16.5		
SAFETY SWITCH 			
PTO Safety	Standard		
Neutral Safety Switch	Standard		
Clutch Safety Switch	Standard		
CAPACITY (LTRS)(+/-5%) 			
Fuel Tank (Lit)	22		
TURNING RADIUS 			
Without brakes (m) as per standard tyres	3.05 (RHS), 2.62 (LHS)		
TYRE 			
Front	6.00-12		
Rear	8.30-20		
DIMENSION & WEIGHT(+/-5%) 			
Weight (Kg)	1235		
Wheel Base (mm)	1570		
Total Length (mm)	2895		
Total Width (mm)	1215 (max)-1050 (min)		
Height (mm) Up to ROPS	2325		
Min Ground Clearance (mm)	240		
Front Track (mm)	885		
Rear Track (mm)	960		
OTHERS 			
Fuel Indicator Gauge	Standard		
Front Tow Hook	Standard		
Front & Rear Weights with std. Ballast	Front weights - 2 x 15 Kg		
Trailer Hitch	Towbar, Drawbar (optional)		
ROPS	Yes		
OPTIONAL FEATURES 			
Cabin Option	Yes		
TYRES			
			
Radial Agri: Front Rear 6.5/80-12 280/70 R18	Turf: Front Rear 25x8,50-14 13.60-16	Ind: Front Rear 23x8,50-12 33x15,50-16,5	Galaxy Pro F - 220/55R12 R - 280/70R16
Front loader	YES optional		

*Data and specifications are subject to change without any advance notice due to continuous product improvement and development. All Dimensions are with standard tyres.



H26



ALSO AVAILABLE WITH CABIN

REMASTERED TRANSMISSION

The high comfort level of this tractor features high end transmission, enabling ease of performance in all terrains.



MID & REAR
PTO



SEPARATE PEDAL
FOR FORWARD
& REVERSE



CRUISE
CONTROL



QUICK ATTACH
MOWER

UPGRADE
YOUR FARM
WITH ADDED

VERSATILITY & COMFORT



INTEGRATED
LOADER
JOYSTICK (OPTIONAL)



MULTI TYRE OPTIONS
(AGRI, INDUSTRIAL & TURF TYRE)



QUICK ATTACHED
LOADER

























SYNCHROMESH
SHUTTLE

S 26
SHUTTLE XL



SPECIFICATIONS

FEATURES		
ENGINE 		
Engine Type	3-Cylinder Diesel Engine	
HP Category	26	
No. of Cylinders	3	
Aspiration	Naturally	
Cubic Capacity (cc)	1319	
Rated RPM (+/-25mm)	2500	
Air Cleaner	Dry	
Cold Start	Standard	
Max Torque (Nm)	76.3	
Exhaust	Silencer in the engine compartment, downward discharge	
TRANSMISSION 		
Drive	4 WD	
Clutch	Single Clutch	
Gearbox	9 Forward + 9 Reverse	
Front Axle	4WD	
Transmission	Constant Mesh with Synchromesh Shuttle Lever	
SPEED (FORWARD) 		
Maximum Speed (Km/Hr)	21.46 @2760 fly up	
Minimum Speed (Km/Hr)	1.14@rated	
BRAKES 		
Brakes	Oil Immersed	
Type of Actuation	Mechanical	
Parking Brake	Independent	
DIFFERENTIAL LOCK 		
Differential Lock	Yes, Foot Operated	
PTO 		
PTO (rpm)	540/540E	
PTO (actuation)	Mechanical	
STEERING 		
Steering	Power steering	
ELECTRICAL 		
Battery	12V, 65 Ah	
Alternator	12V, 42 A	
Seven Pin Trailer Socket	Standard	
HYDRAULICS 		
3 Point Linkage	Cat 1-N	
Stay Bars	Anchor Chain	
Additional hydraulic circuit	1 DA	

FEATURES			
Hydraulic Lifting Capacity	600 Kg		
Lift Rods	Standard		
Litre per Minute(LPM)	17.8		
SAFETY SWITCH 			
PTO Safety	Standard		
Neutral Safety Switch	Standard		
Clutch Safety Switch	Standard		
CAPACITY (LTRS)(+/-5%) 			
Fuel Tank (Lit)	20		
TURNING RADIUS 			
Without brakes (m) as per standard tyres	3.02 (RHS), 3.15 (LHS)		
TYRE 			
Front	6.00-12		
Rear	8.30-20		
DIMENSION & WEIGHT(+/-5%) 			
Weight (Kg)	1250		
Wheel Base (mm)	1570		
Total Length (mm)	2895		
Total Width (mm)	1215 (max)-1050 (min)		
Height (mm) Up to ROPS	2325		
Min Ground Clearance (mm)	240		
Front Track (mm)	885		
Rear Track (mm)	960		
OTHERS 			
Fuel Indicator Gauge	Standard		
Front Tow Hook	Standard		
Front & Rear Weights with std. Ballast	Front weights-2 x 15		
Trailer Hitch	Towbar, drawbar (optional)		
ROPS	Yes		
OPTIONAL FEATURES 			
Cabin Option	Optional only heater		
TYRES			
			
Radial Agri: Front Rear	Turf: Front Rear	Ind: Front Rear	Galaxy Pro
6.5/80-12 280/70 R18	25x8,50-14 13.60-16	23x8,50-12 33x15,50-16,5	R- 280/70R16
Front loader	YES optional		

*Data and specifications are subject to change without any advance notice due to continuous product improvement and development. All Dimensions are with standard tyres.



Solis

INTERNATIONAL TRACTORS LIMITED

International Business Office: Teri School of Advanced Studies, Plot No.10, Institutional Area, Vasant Kunj, New Delhi-110070 (India) | **Phone:** +91 11 66 45 5200

Work: Jalandhar Road, Hoshiarpur - 146022, Punjab (India) | **Phone:** +91-01882-522220/ 522221 | **Fax:** +91- 01882-522222

Email: info@solisworld.com | **URL:** www.solistractors.com

Follow us on:

www.facebook.com/SolisTractors/ www.twitter.com/SolisTractor www.linkedin.com/company/solis-tractors-international
www.instagram.com/solis_tractors www.youtube.com/c/SolisTractors

