

CULTIVATOR

SINGLE SPRING LOADED SERIES













SALIENT FEATURES

- Robust frame
- Heavy duty forged tyne
- Heavy duty springs to absorb sudden impact
- Superior powder coated paint

SINGLE SPRING LOADED SERIES

Solis Cultivators helps in proper soil manipulation to prepare smooth & loose seedbed before planting. It loosens & aerates the soil to a depth of 9 inches in most effective and economical way.

TECHNICAL SPECIFICATIONS

| |  Model |  No. of Tyne |  Frame (mm) |  Tyne Size (mm) |  Shovels (mm) |  Width (mm) |  Working Width (mm) |  Height (mm) |  Weight (Kg. Approx.) |  Tractor Power (HP) |
|-----------------------------|---|---|--|--|--|--|--|---|--|--|
| Single Spring Loaded Series | SL-CL-SS11 | 11 | 72x72x5 (Sq. Pipe) | 26 | 8(EN-45) | 2620 | 2570 | 1170 | 350 | 45-50 |
| | SL-CL-SS13 | 13 | | | | 3070 | 3020 | | 400 | 55-60 |
| | SL-CL-SS15 | 15 | | | | 3520 | 3470 | | 450 | 60-65 |
| | SL-CL-SS17 | 17 | | | | 3970 | 3920 | | 500 | 70-90 |

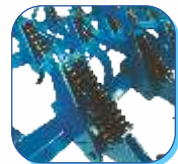

SINGLE ACTING SPRING DESIGN



ENHANCED BEAM CLEARANCE



REVERSIBLE SHOVELS

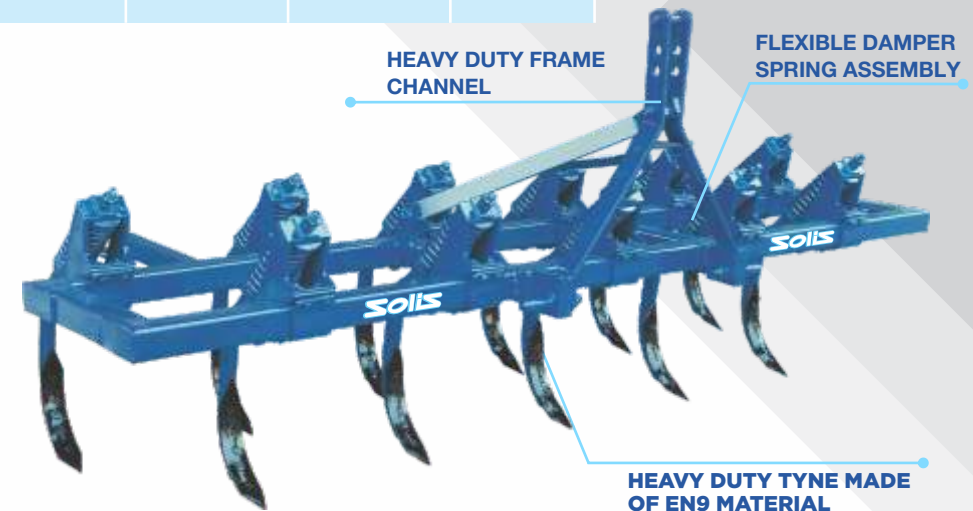

Solis

INTERNATIONAL TRACTORS LIMITED

International Business Office: Teri School of Advanced Studies, Plot No.10, Institutional Area, Vasant Kunj, New Delhi-110070 (India)

Phone: +91 11 66 45 5200 | **Work:** Jalandhar Road, Hoshiarpur - 146022, Punjab (India) | **Phone:** +91-01882-522220/ 522221

Fax:+91- 01882-522222 | **Email:** info@solis.com | **URL:** www.solistractors.com

Auth. Dealer